

Model	Description
VSXT..	two-way valve DN 1/2" - 3/4"; Kvs m ³ /h 0,25 - 6
VMXT..	three-way valve DN 1/2" - 3/4"; Kvs m ³ /h 0,25 - 6 (4 angle way)
VTXT..	three-way valve with built in by-pass DN 1/2" - 3/4"; Kvs m ³ /h 0,25 - 6 (4 angle way)

APPLICATION AND USE

V.XT series valves are used for hot and chilled water control in two- or four-pipe fan coil units, zone plants, solar plants, small re-heaters and dehumidifiers, in electric/electronic temperature control systems. They are motorized by Controlli MVTx03S actuators.

MANUFACTURING CHARACTERISTICS

Brass valve body. Fortron plug with EPDM double OR. Stainless steel stem. Stem packing with EPDM double OR. All models are normally closed, i.e. the action of the valve spring makes the plug move to the upper seat, even with disassembled actuator.

TECHNICAL CHARACTERISTICS

Construction: PN16;
control characteristics: equal percentage A-AB port, linear B-AB for Kv 0.25 to 2.5; linear A-AB port, linear B-AB for Kv4 and Kv6;
stroke: 5,5mm;
max fluid speed: 3m/s
allowed fluids: - water 5T95 °C
- glycol-added max 30%
weight: see dimensions
connections: male threaded gas connection flat or conic tight

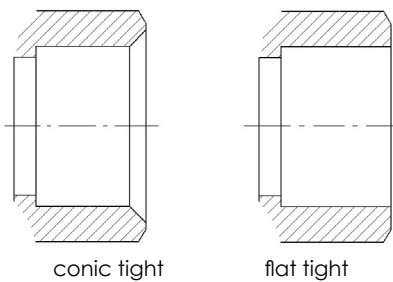

OPERATION

V.XT valves without the actuator are normally closed (with reference to the direct way). The plug with double EPDM O-ring ensures tight close-off on both straight and angle way in all V.XT models. The valve tight close-off with DeltaP max is guaranteed by the valve spring, even without actuator.



INSTALLATION AND MOUNTING

Before installing the valve, make sure that pipes are clean, free from foreign matter, perfectly aligned with the valve body and not subjected to vibration.

The valve can be mounted in any position but with the stem pointing downwards. 3-way valves must be used as mixing valves (see fig. 4 and 5).

Should valves be installed as diverting (one inlet two outlets) a reduction to 1/3 of the declared value will result in the max. differential pressure for standard operation.

Allowed mounting position

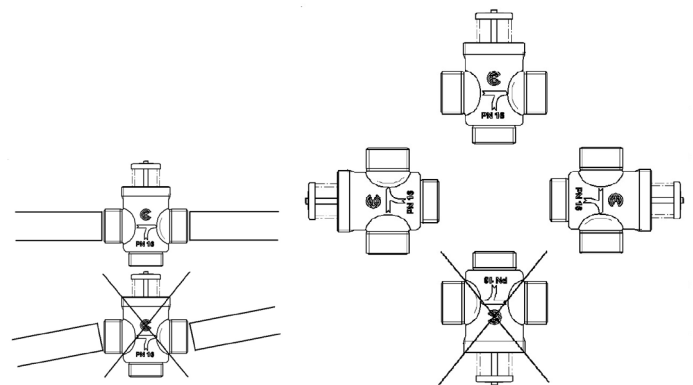

Type	Models	Connections	Flow rate (m³/h)	Dp max (bar)	
Two-way	VSXT09P	G 1/2 Flat tight	0,25	350	
	VSXT10P		0,4		
	VSXT11P		0,6		
	VSXT12P		1		
	VSXT13P		1,6		
	VSXT1P		2		
	VSXT21P	G 3/4 Flat tight	2,5	250	
	VSXT24P		4	150	
	VSXT26P		6		
	Three-way	VMXT09P	G 1/2 Flat tight	0,25 (0,25)	350
		VMXT10P		0,4 (0,4)	
		VMXT11P		0,6 (0,6)	
		VMXT12P		1 (0,6)	
		VMXT13P		1,6 (1)	
VMXT1P		2 (1,6)			
VMXT21P		G 3/4 Flat tight	2,5 (2)	250	
VMXT24P			4 (2,5)	100 (40 angle way)	
VMXT26P			6 (4)		
Three-way		VMXT09	Conic tight	0,25 (0,25)	350
	VMXT10	0,4 (0,4)			
	VMXT11	0,6 (0,6)			
	VMXT12	1 (0,6)			
	VMXT13	1,6 (1)			
	VMXT1	2 (1,6)			
	VMXT21	G 3/4 Conic tight	2,5 (2)	250	

Type	Models	Connections	Flow rate (m³/h)	Dp max (bar)		
Three-way valves with built-in by-pass (4-ports)	VTXT09P	G 1/2 Flat tight	0,25 (0,25)	350		
	VTXT10P		0,4 (0,4)			
	VTXT11P		0,6 (0,6)			
	VTXT12P		1 (0,6)			
	VTXT13P		1,6 (1)			
	VTXT1P		2 (1,6)			
	VTXT21P	G 3/4 Flat tight	2,5 (2)	250		
	VTXT24P		4 (2,5)	100 (40 angle way)		
	VTXT26P		6 (4)			
	Three-way valves with built-in by-pass (4-ports)	VTXT09	G 1/2 Conic tight	0,25 (0,25)	350	
		VTXT10		0,4 (0,4)		
		VTXT11		0,6 (0,6)		
		VTXT12		1 (0,6)		
		VTXT13		1,6 (1)		
		VTXT1		2 (1,6)		
		VTXT21	G 3/4 Conic tight	2,5 (2)	250	
		Three-way valves with built-in by-pass (4-ports)	VTXT09P4	G 1/2 flat tight interaxis 40 mm	0,25 (0,25)	350
			VTXT10P4		0,4 (0,4)	
			VTXT11P4		0,6 (0,6)	
	VTXT12P4		1 (0,6)			
VTXT13P4	1,6 (1)					
VTXT1P4	2 (1,6)					
VTX21P4	G 3/4 flat tight interaxis 40 mm		2,5 (2)	250		

DP max = max. diff. press. guaranteed with closed valve and open flow

(*) The values in brackets represent Kvs on angle way.

PRESSURE DROP DIAGRAM

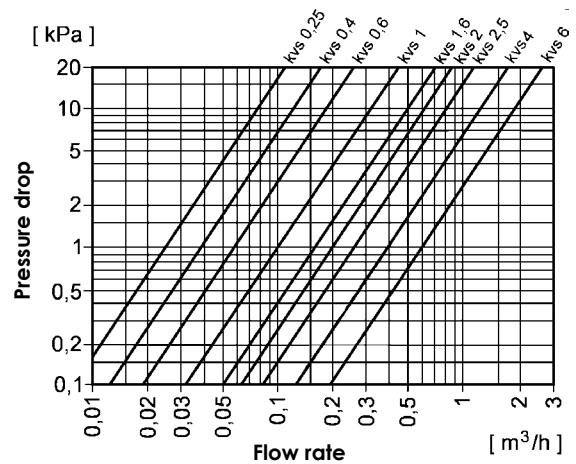

APPLICATION DIAGRAM

2-way valves

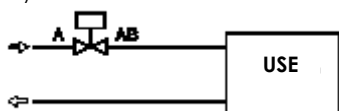

FIG. 3

3-way valves

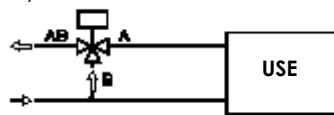

FIG. 4

3-way valves with bypass

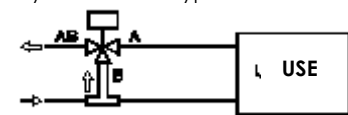
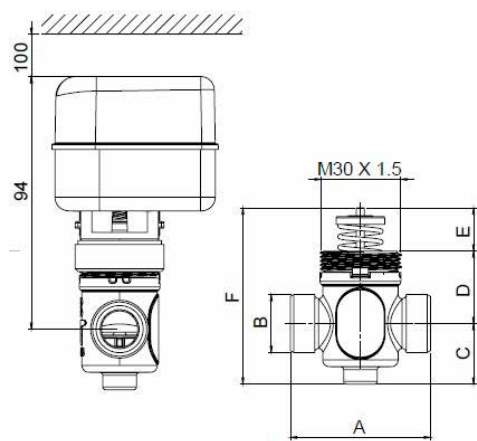

FIG. 5



Valve	Actuator	a	b	c	d	e	f
VSXT09P VSXT10P VSXT11P VSXT12P VSXT13P-VSXT13	MVT203 MVT403 MVT503	52	G1/2"A	22,5	27	15,6	65
VSXT21-VSXT21P		56	G3/4"A	23,6	25,8		

Valve	Actuator	a	b	c	d	e	f
VMXT09P VMXT10P VMXT11P VMXT12P VMXT13P-VMXT13	MVT203S MVT403S MVT503S	52	G1/2"A	25	27	15,6	67,6
VMXT21-VMXT21P		56	G3/4"A	34	25,8		75,4

Valve	Actuator	a	b	c	d	e	f
VTXT09P VTXT10P VTXT11P VTXT12P VTXT13P-VTXT13		52	G1/2"A	35			88,4
VTXT09P4 VTXT10P4 VTXT11P4 VTXT12P4 VTXT13P4 VTXT1P4	MVT203S MVT403S MVT503S	56	G1/2"A	40	27	15,6	93,4
VTXT21-VTXT21P		56	G3/4"A	50	25,8		98,4
VTXT21P4		56	G3/4"A	40	25,8		88,4

Valve	Actuator	a	b	c	d	e	f
VSXT24P VSXT26P	MVT203S			20,5			77,1
VMXT24P VMXT26P	MVT403S MVT503S	78	G3/4" A	36	41	15,6	92,6
VTXT24P VTXT26P				44			107,6

